



ODYSSÉE TECHNOLOGIES

PORTFOLIO

Etudes de gammes (CFAO : Esprit, Top Solid 7.13)
Tournage et fraisage CN (3 à 5 axes, UGV)
Électroérosion fil et enfonçage
Rodage / Rectification plane et cylindrique
Ajustage / ébavurage manuel
Pièces complètes (traitements thermiques et de surface)
Montage, assemblage et essais de sous-ensembles
Constitution de kits



PRÉCISION MÉCANIQUE DE BRIVE
Rue de la gare
19360 MALEMORT
Tél. 05 55 92 20 49
direction.pmb@wanadoo.fr



GRESSET ET ASSOCIÉS SAS
Z.A. des Premiers Sapins
25580 LES PREMIERS SAPINS
Tél. 03 81 60 04 27
contact@gresset-sas.com



SN LAFOURCADE
23, rue de la Paix – B.P.21
65690 BARBAZAN-DEBAT
Tél. 05 62 33 87 03
contact@snl-sas.com

SOMMAIRE

Secteurs industriels



Aéronautique



Spatial



Défense



Energie



**Applications
Industrielles**

Domaines d'activité stratégiques



**Pièces pour
systèmes
hydrauliques**



**Pièces pour la
maintenance
aéronautique**



**Pièces pour le
secteur de
l'énergie**



**Reprise de pièces
de fabrication
additive**



**Montage,
constitution de
sous-ensembles,
kitting**

TUBE DE TORSION

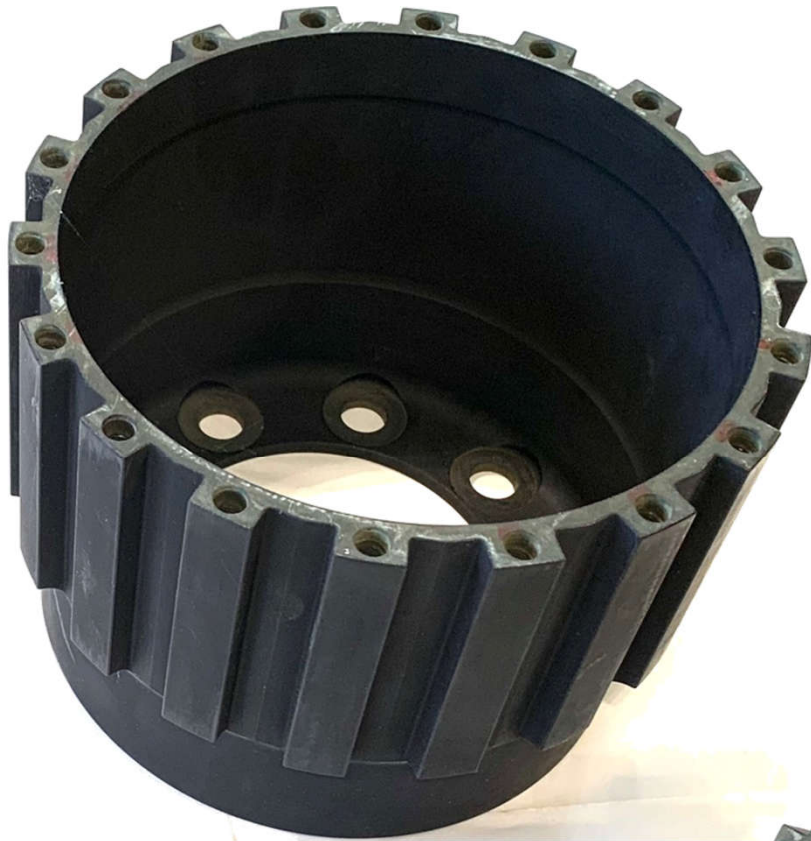

FERRURE



RACCORD DE LUBRIFICATION

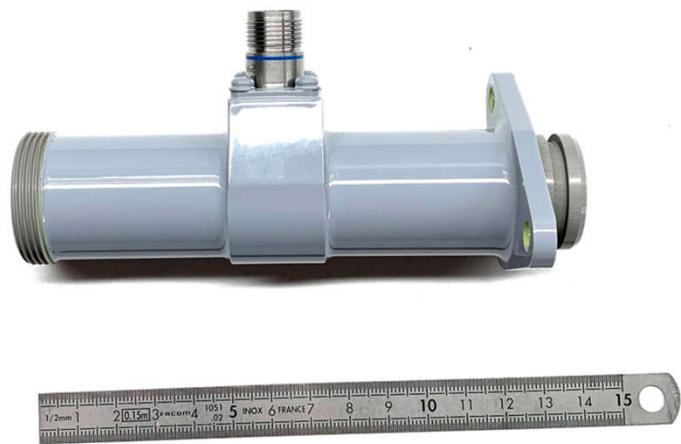

CORPS DE VANNE

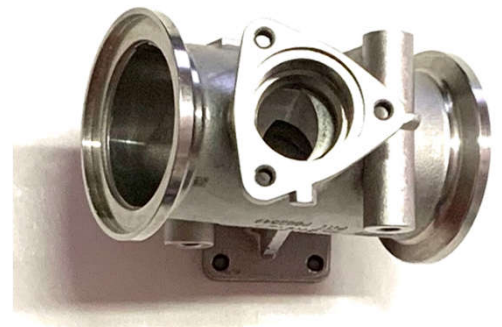

CORPS

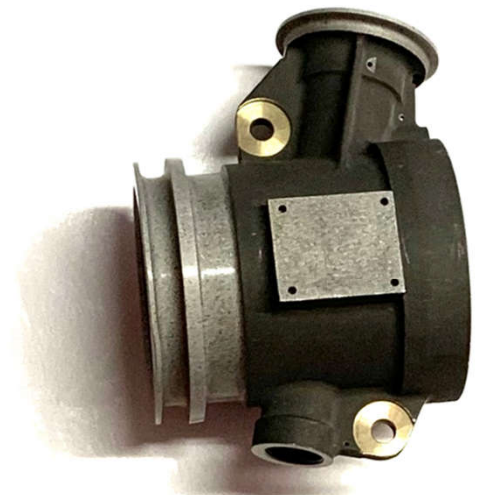

COURONNES HYDRAULIQUE



CORPS EMBRAYAGE



BOUCHON DE CENTRAGE

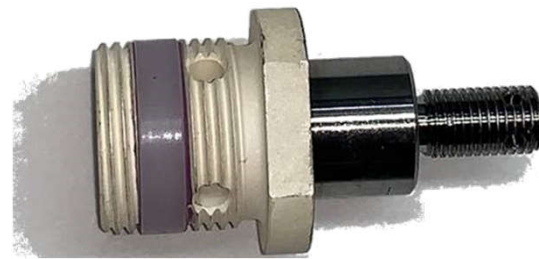

PLATEAU D'EMBRAYAGE

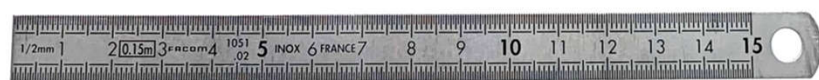

SUPPORT GACHETTE LEVIER ARMEMENT



GALET COMMANDE



POUSSOIR DE LA GACHETTE



GACHETTE



AXE GACHETTE



RESSORT POUSSOIR GACHETTE

CARTER ALUMINIUM

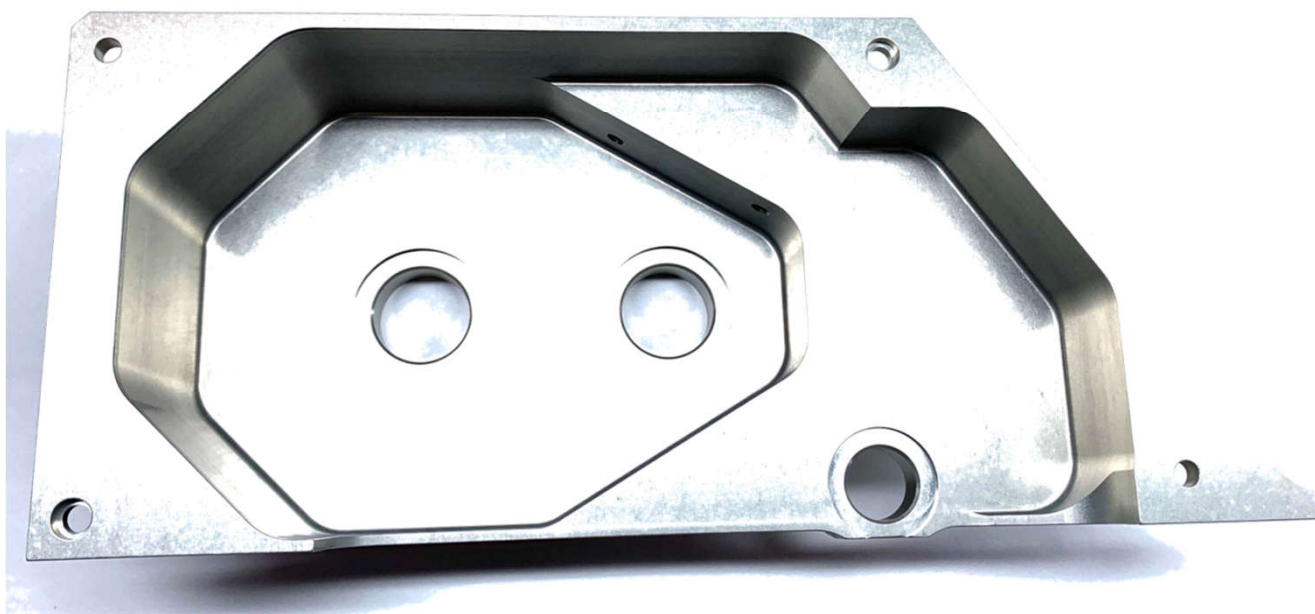



SOCLE MECANO MONTE



GLISSIÈRE INTRODUCTEUR COMPLETE



EQUILIBREUR 105 mm



REPRISE DE PIÈCES DE FONDERIE



KIT SPECIFIQUE



SYSTÈME VERROUILLAGE

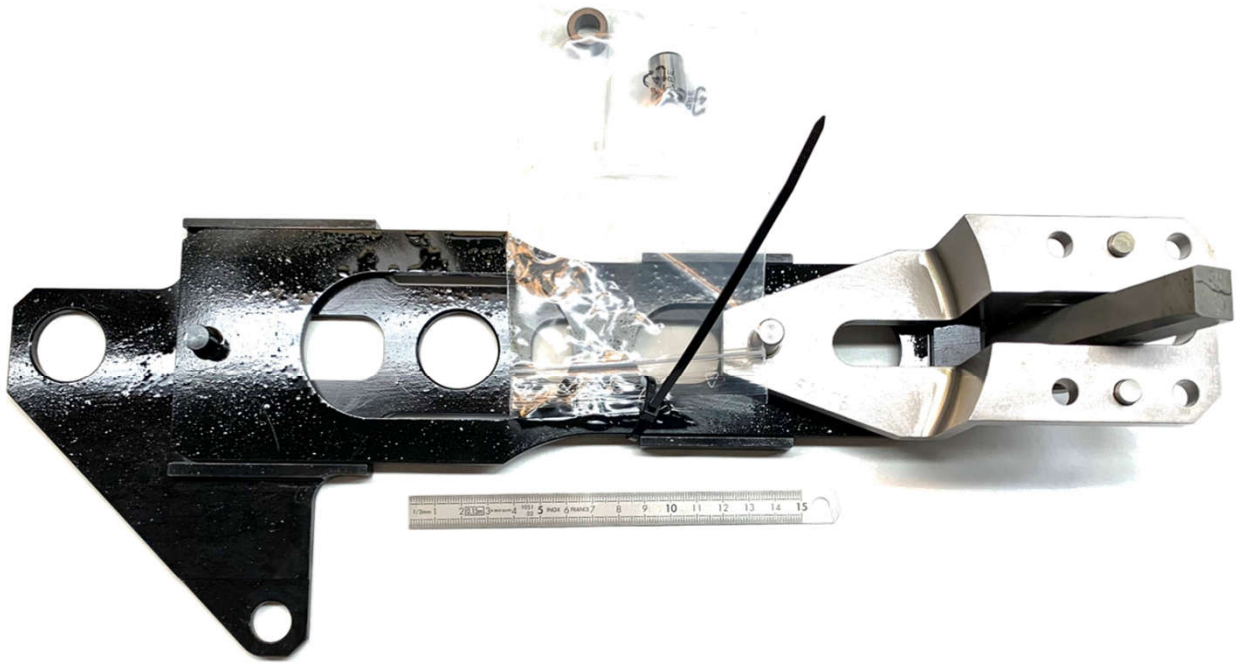

COMMANDE VERROU CHAMBRE



BRIDE MOBILE PIVOT ARME



AXE



PION Ø8X10



CHAPE VERROU CHAMBRE

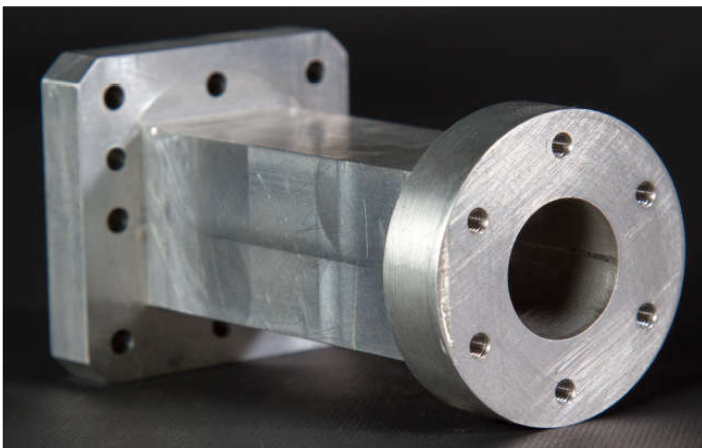
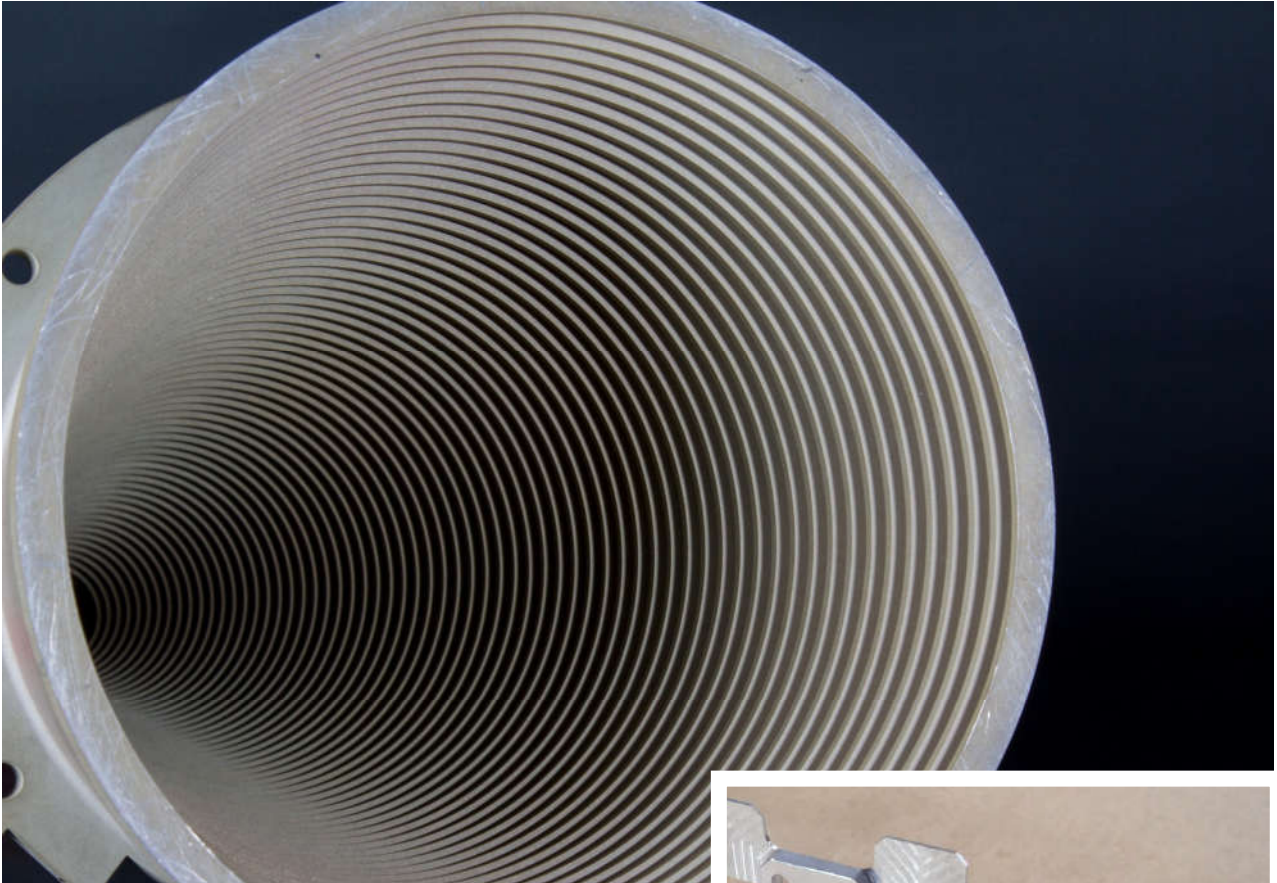

AUBES DE TURBINES

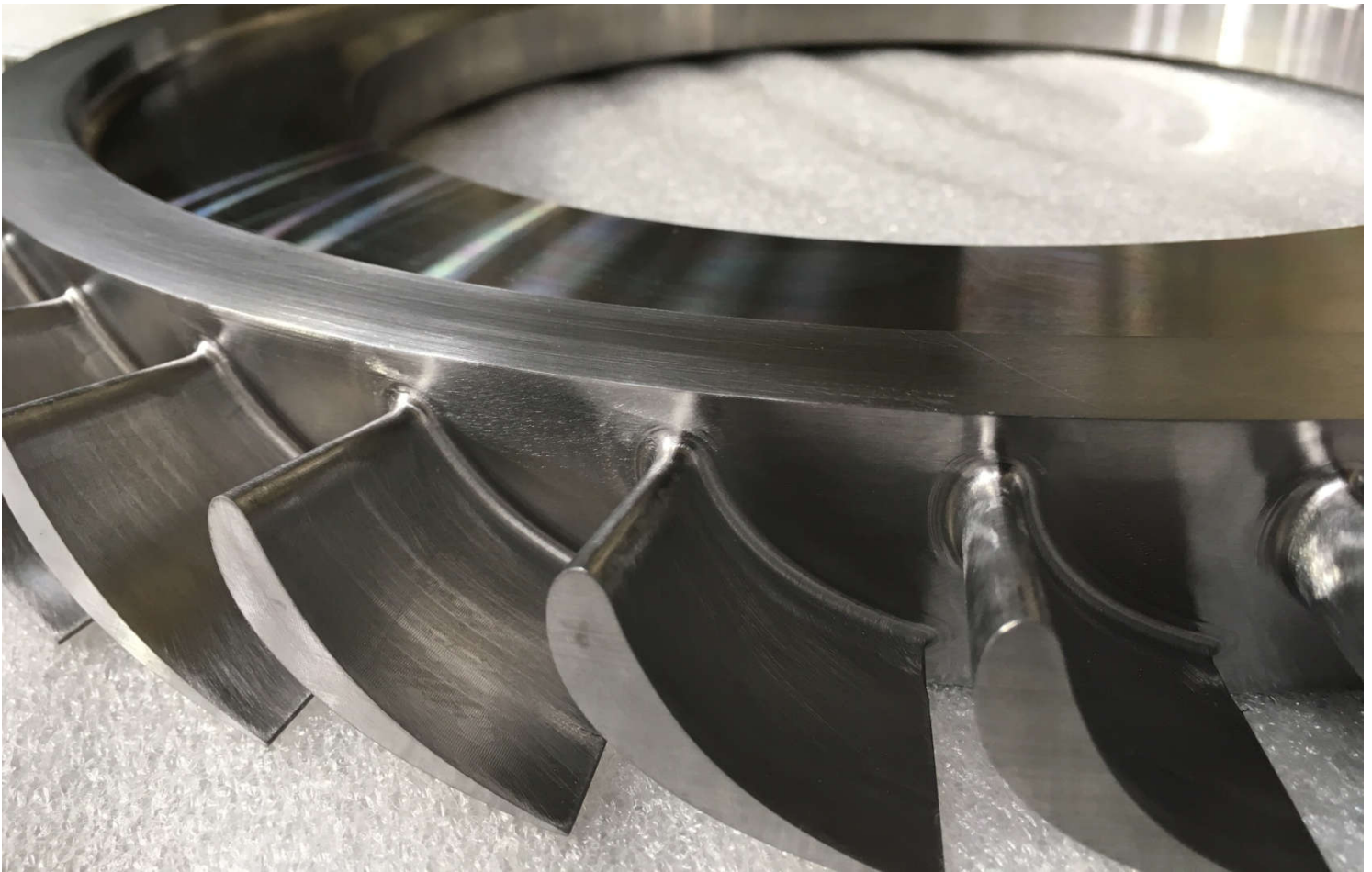

CORPS PRINCIPAL EQUIPÉ



SUPPORT MODULE



CORPS DE BROCHE



BOITIER MOTORISATION EQUIPÉ

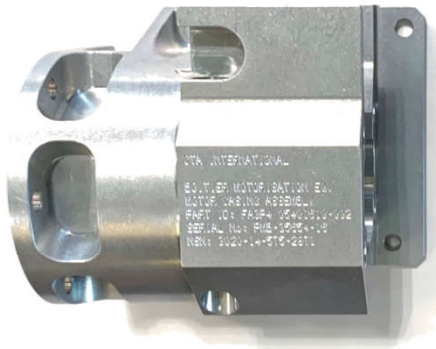

BOITIER MOTORISATION



ARBRE MOTEUR



COUVERCLE MOTO REDUCTEUR



CORPS DU LIMITEUR DE COUPLE



PIGNON MOTO REDUCTEUR



DISQUE EXTERNE POUR LIMITEUR DE COUPLE



DISQUE INTERNE POUR LIMITEUR DE COUPLE



BAGUE DE FROTTEMENT



ENTRETOISE PIGNON MOTEUR



BAGUE BRONZE

BRAS COULISSANT

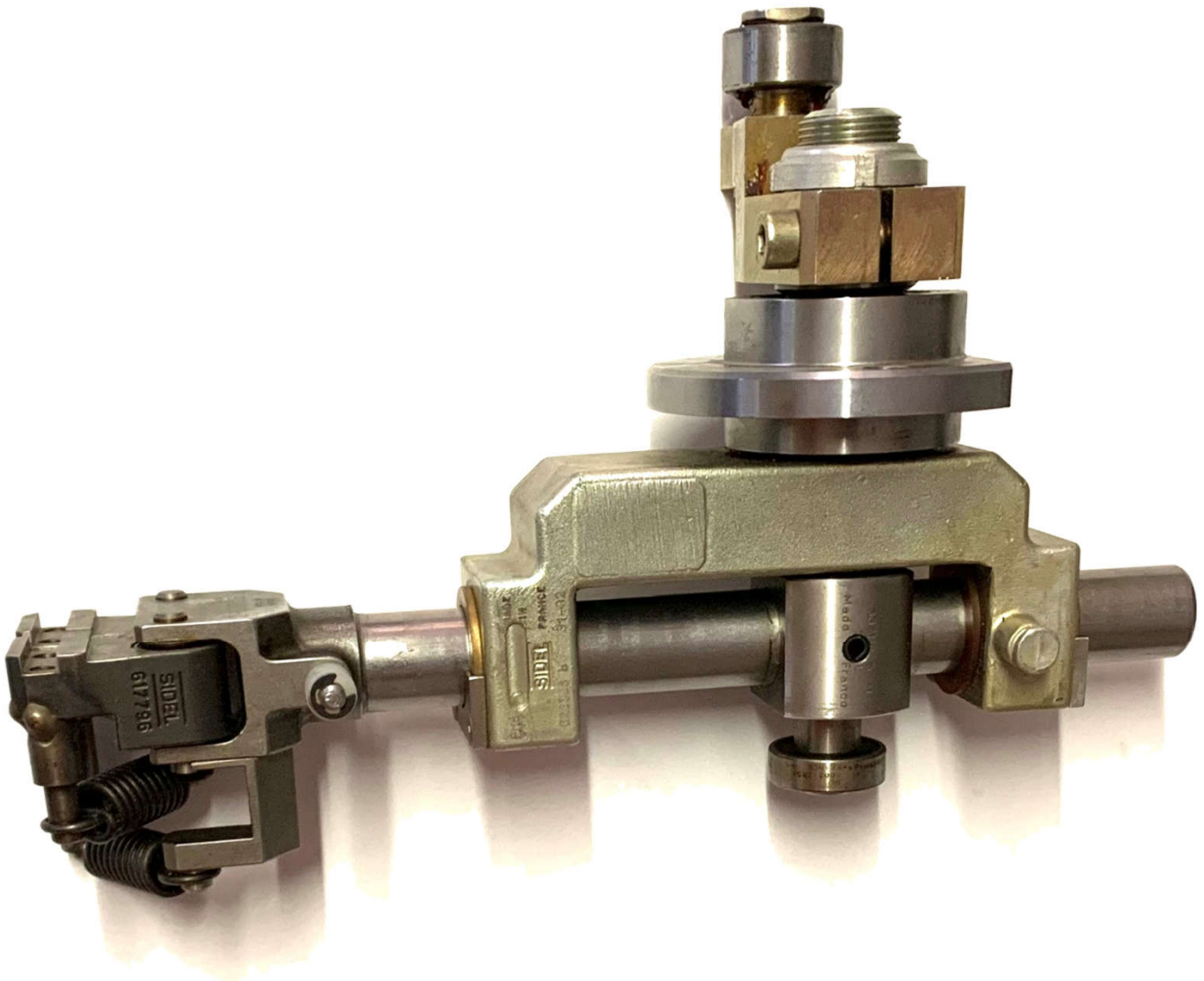

RATELIER



PIGNON SANS JEU

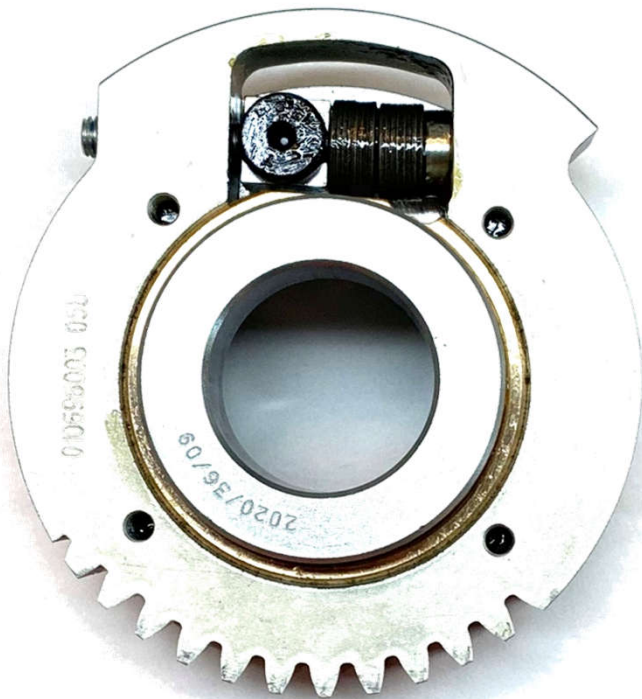
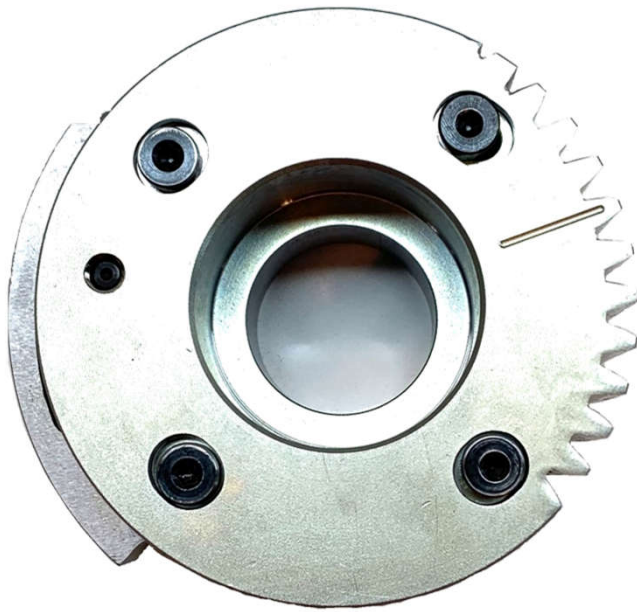

PLAQUE FROIDE LIQUIDE

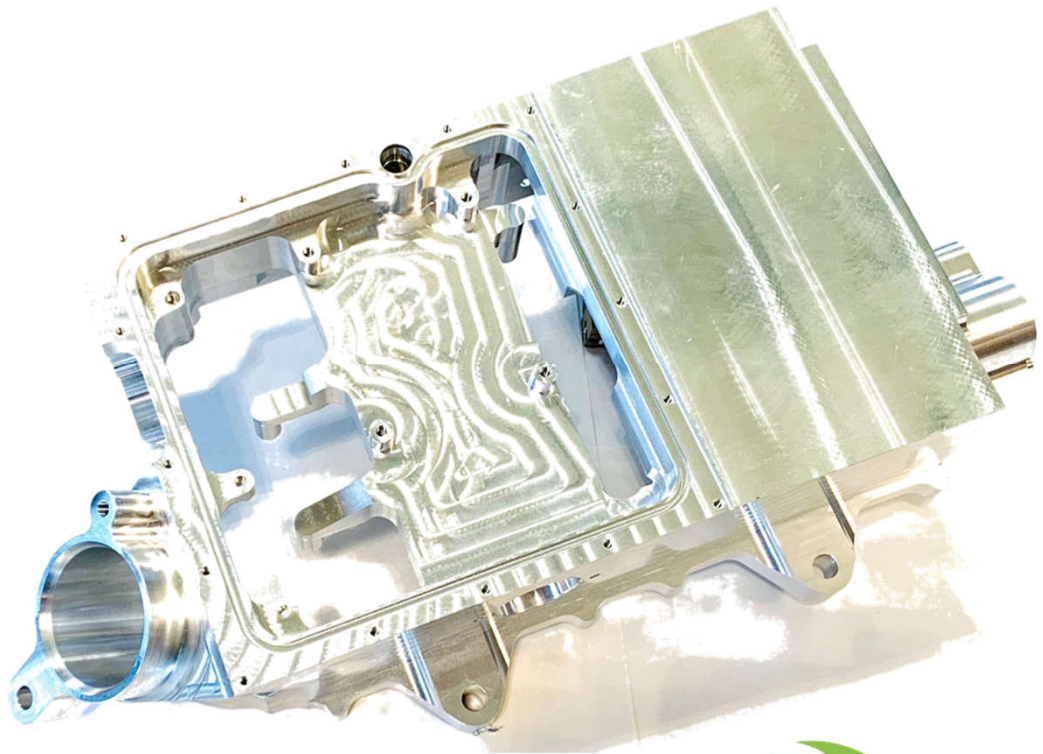
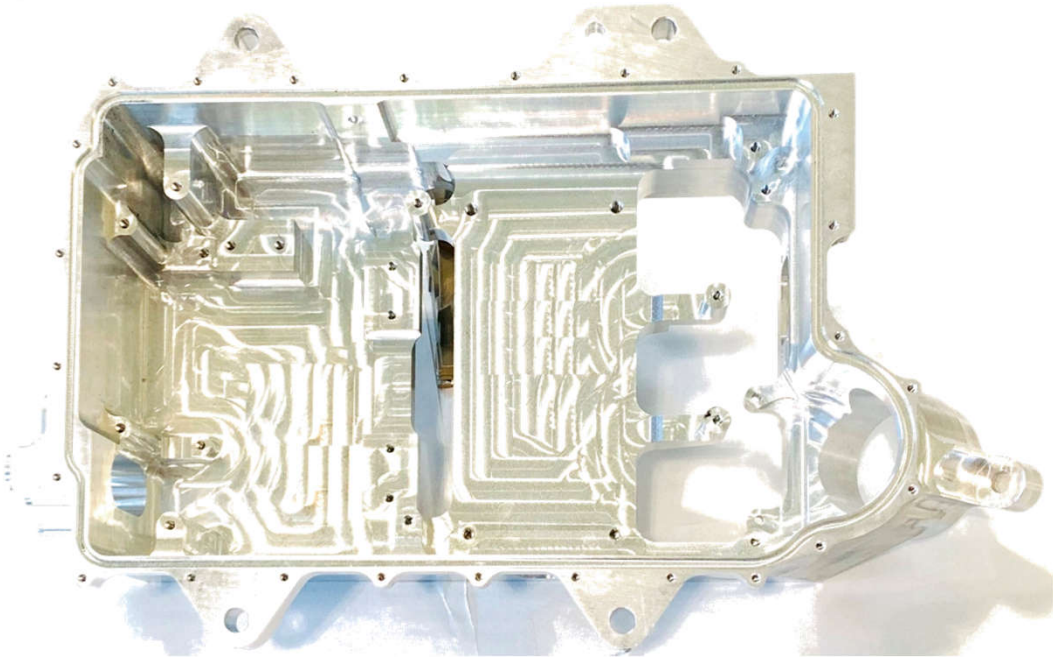



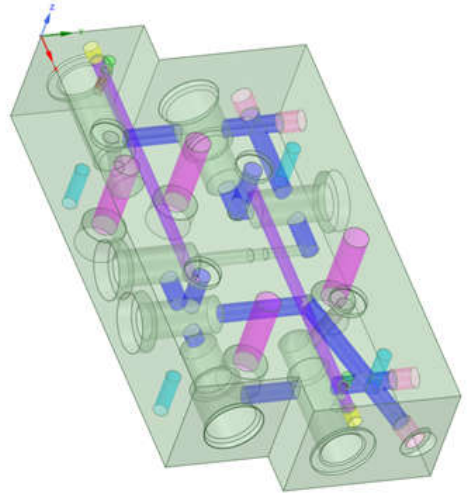
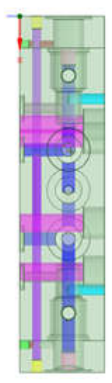
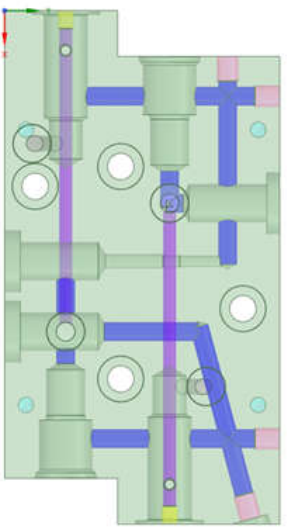

CORPS MANIFOLD, SIÈGES DE CLAPET, CHEMISES, ect,

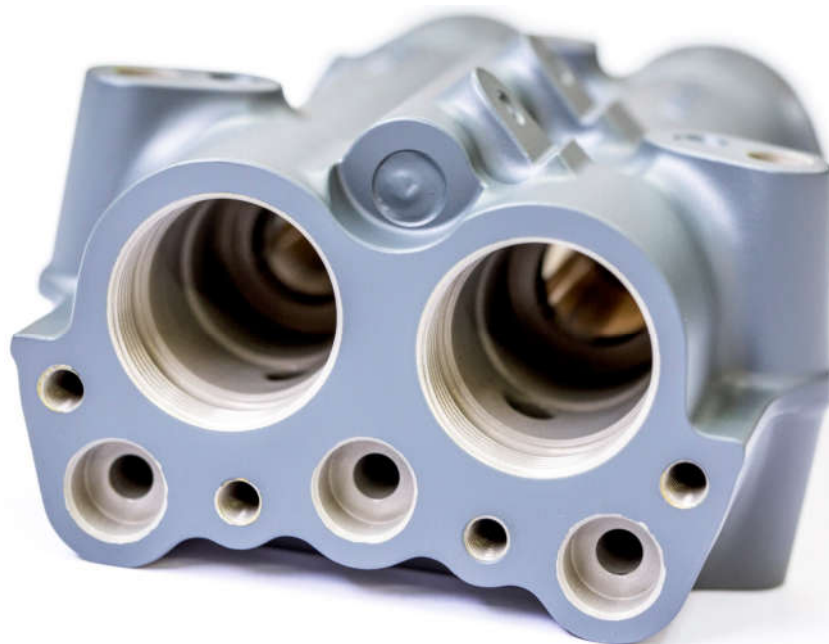
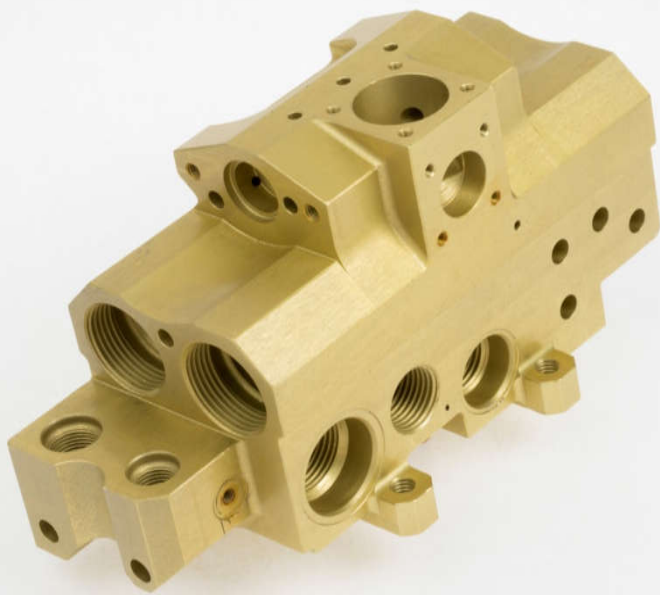

Pièces pour systèmes hydrauliques

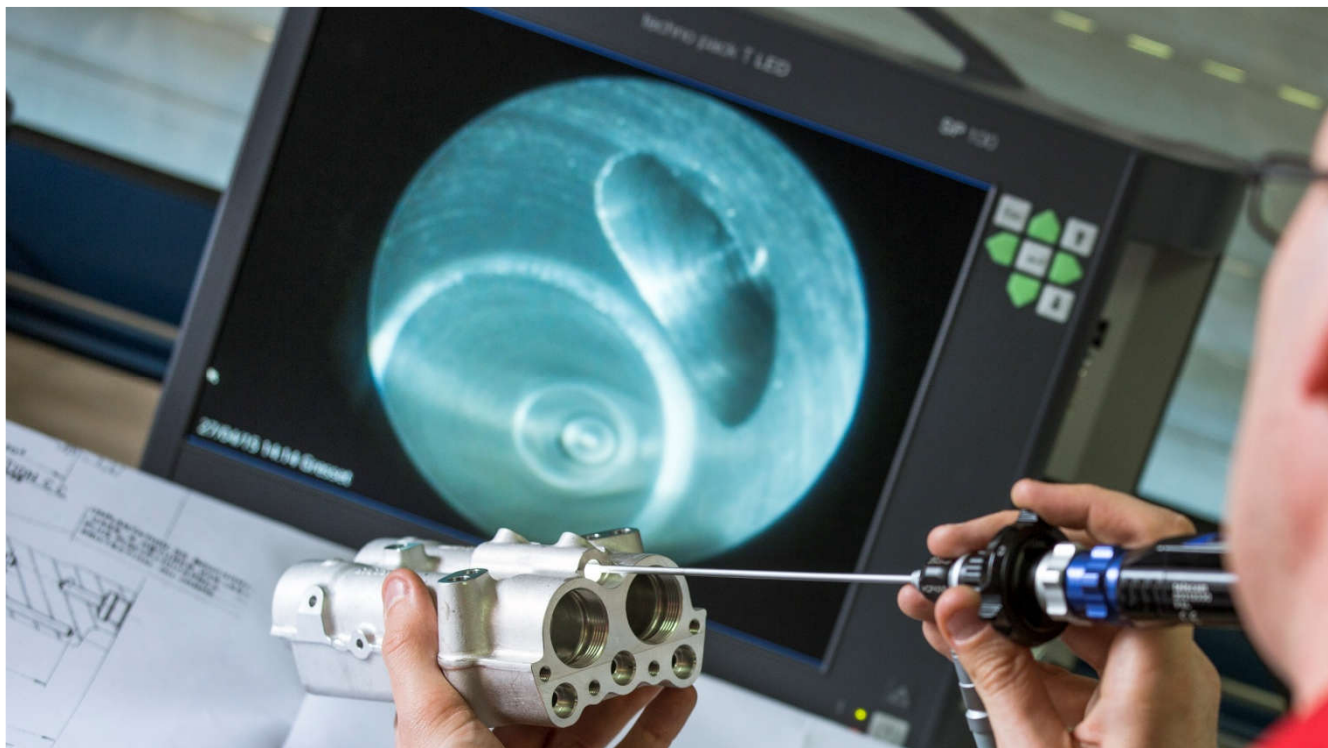

Reprise de pièces de fabrication additive

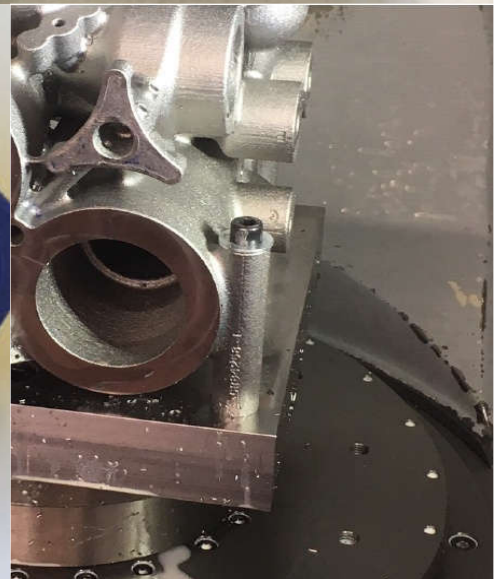
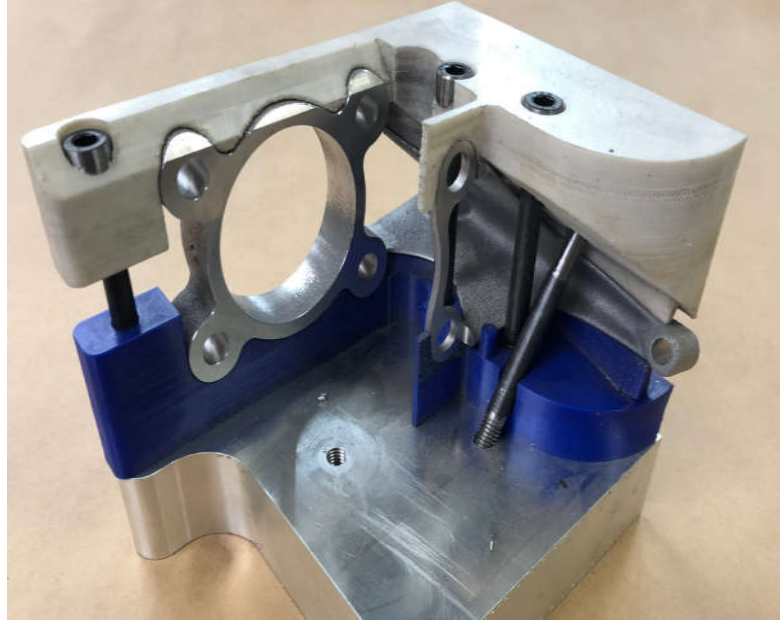

Montage, constitution de
sous-ensembles, kitting

ROBINET COUPE FEU

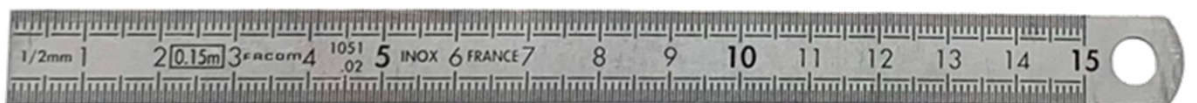
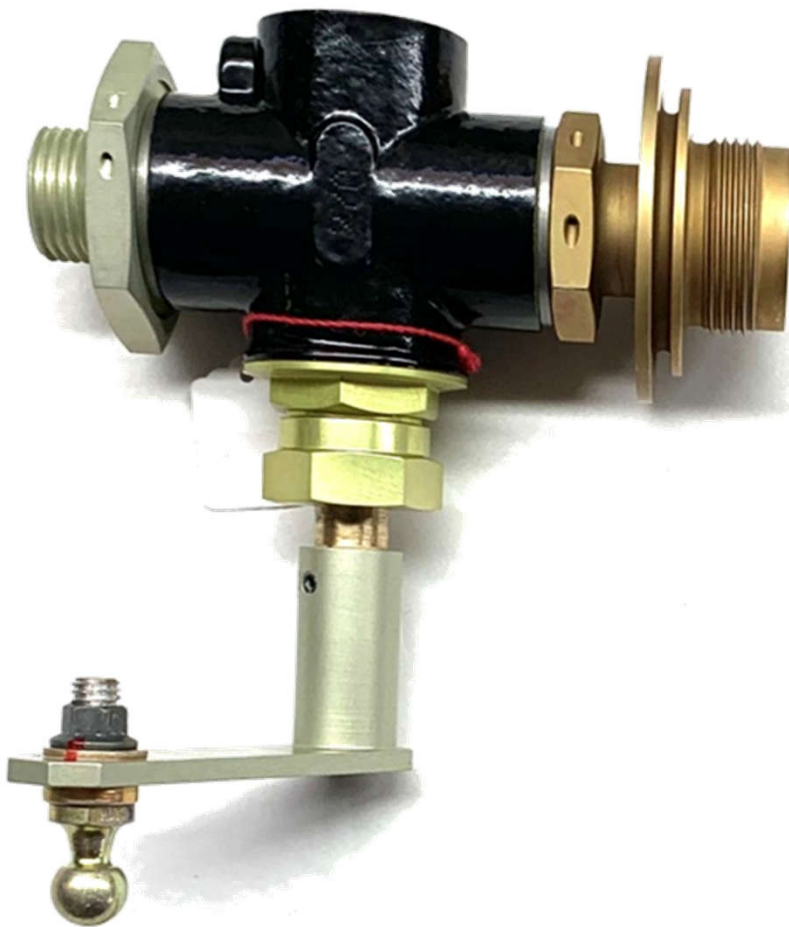

ELEMENT SUPPORT



PLATEAU DROIT



SOUS-ENSEMBLES ARMEMENT



PIGNON ARRIERE



PIGNON REDUCTEUR



PIGNON D'ALIMENTATION



COUVERCLE



Montage, constitution de
sous-ensembles, kitting

CONSTITUTION DE KIT



BAGUE



PALIER BRONZE ET RONDELLES DE CALAGE



MAQUETTE

PIÈCES POUR ESSAIS EN SOUFFLERIE

